



ORACLE®

Cloning und Laufzeitüberwachung von Oracle Fusion Middleware

Sören Halter

Principal Sales Consultant



The following is intended to outline our general product direction. It is intended for information purposes only, and may not be incorporated into any contract. It is not a commitment to deliver any material, code, or functionality, and should not be relied upon in making purchasing decisions. The development, release, and timing of any features or functionality described for Oracle's products remains at the sole discretion of Oracle.

Agenda

- **Wichtige Konzepte und Begriffe**
- Kopieren von Oracle Fusion Middleware
- Laufzeitüberwachung von Oracle Fusion Middleware



Oracle Fusion Middleware im Gesamtstack



- Oracle liefert den gesamten Stack vom Speicher bis zur Applikation
- Fusion Middleware ist ein zentraler Baustein

Oracle Fusion Middleware Umgebung

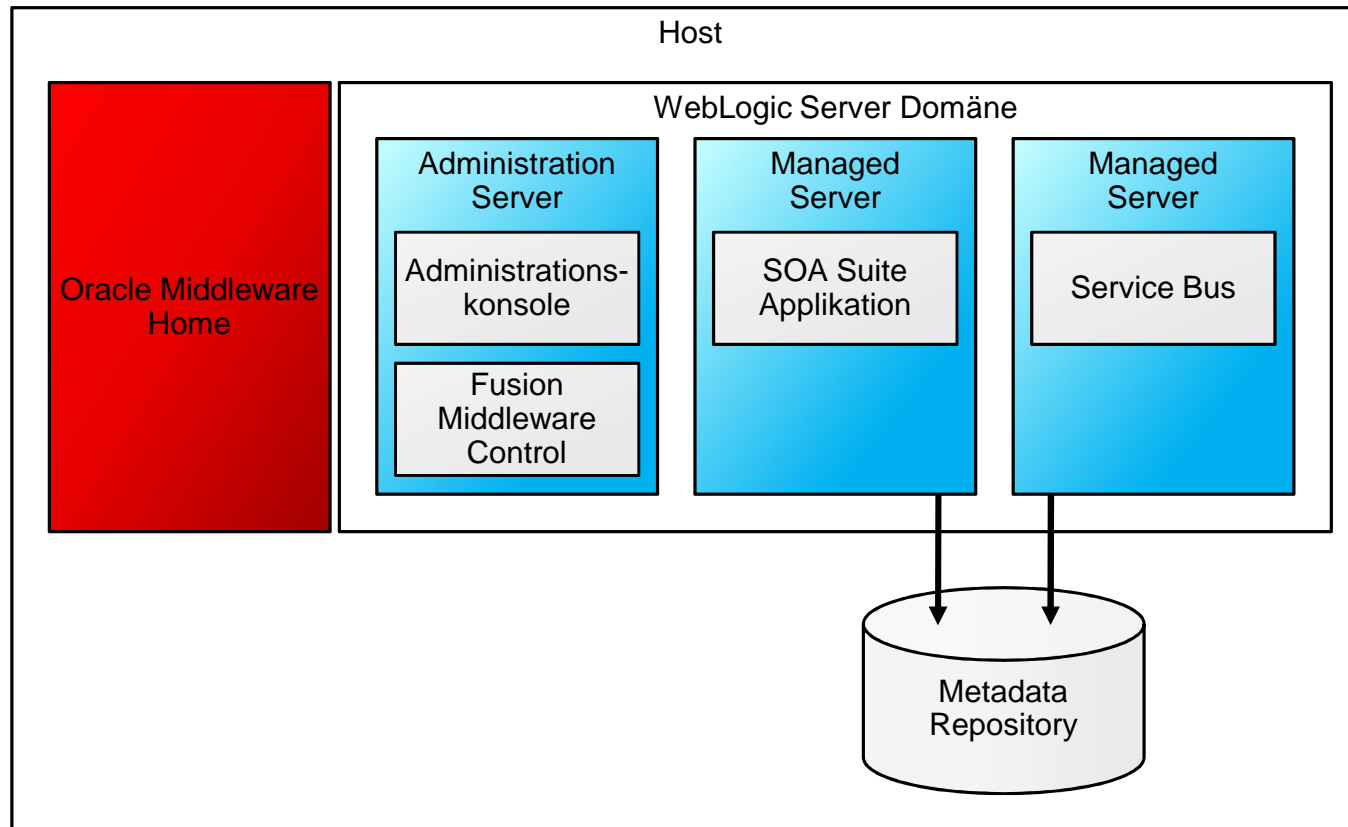

Oracle WebLogic Server Domäne

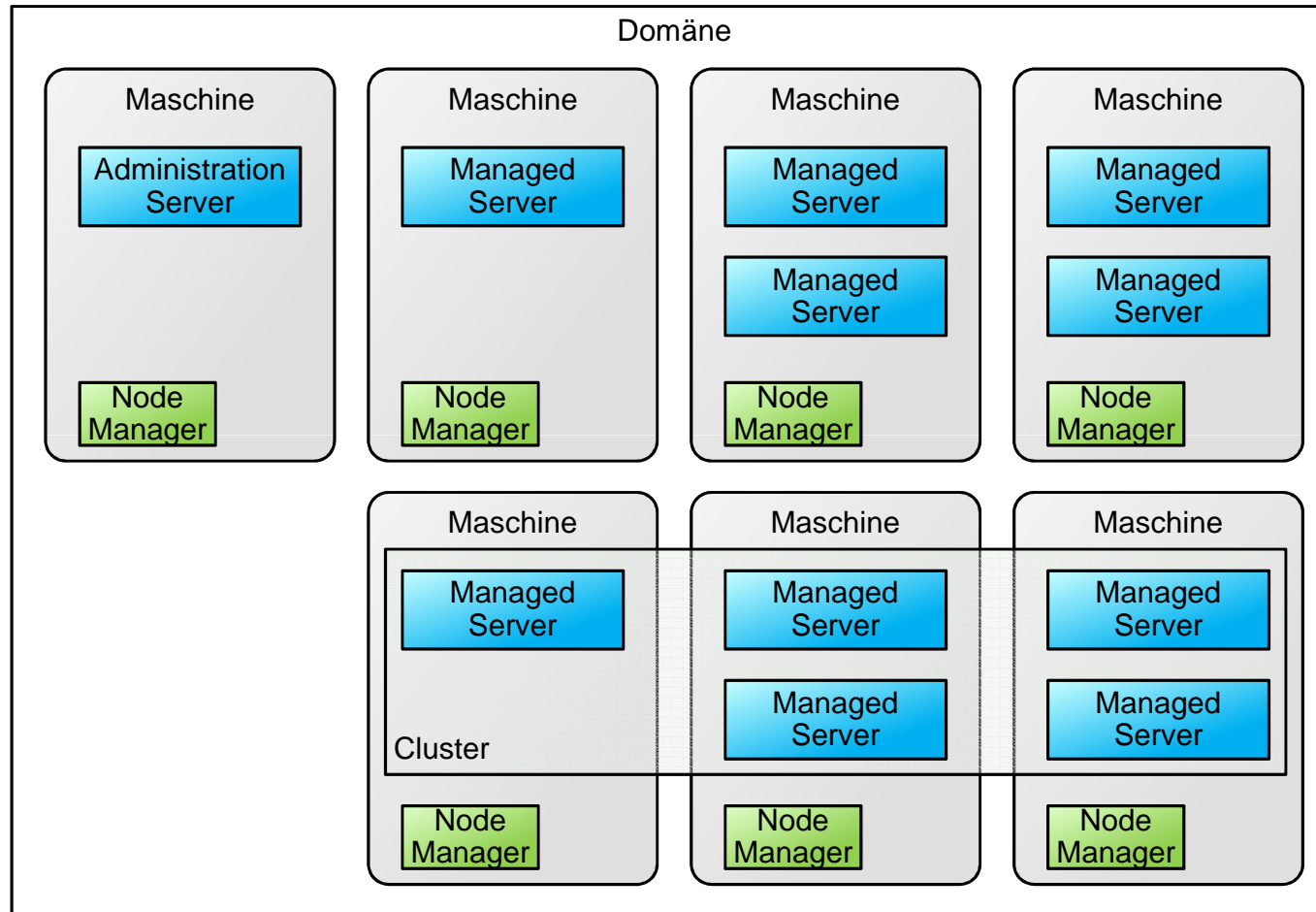

Vereinfachte Verzeichnisstruktur

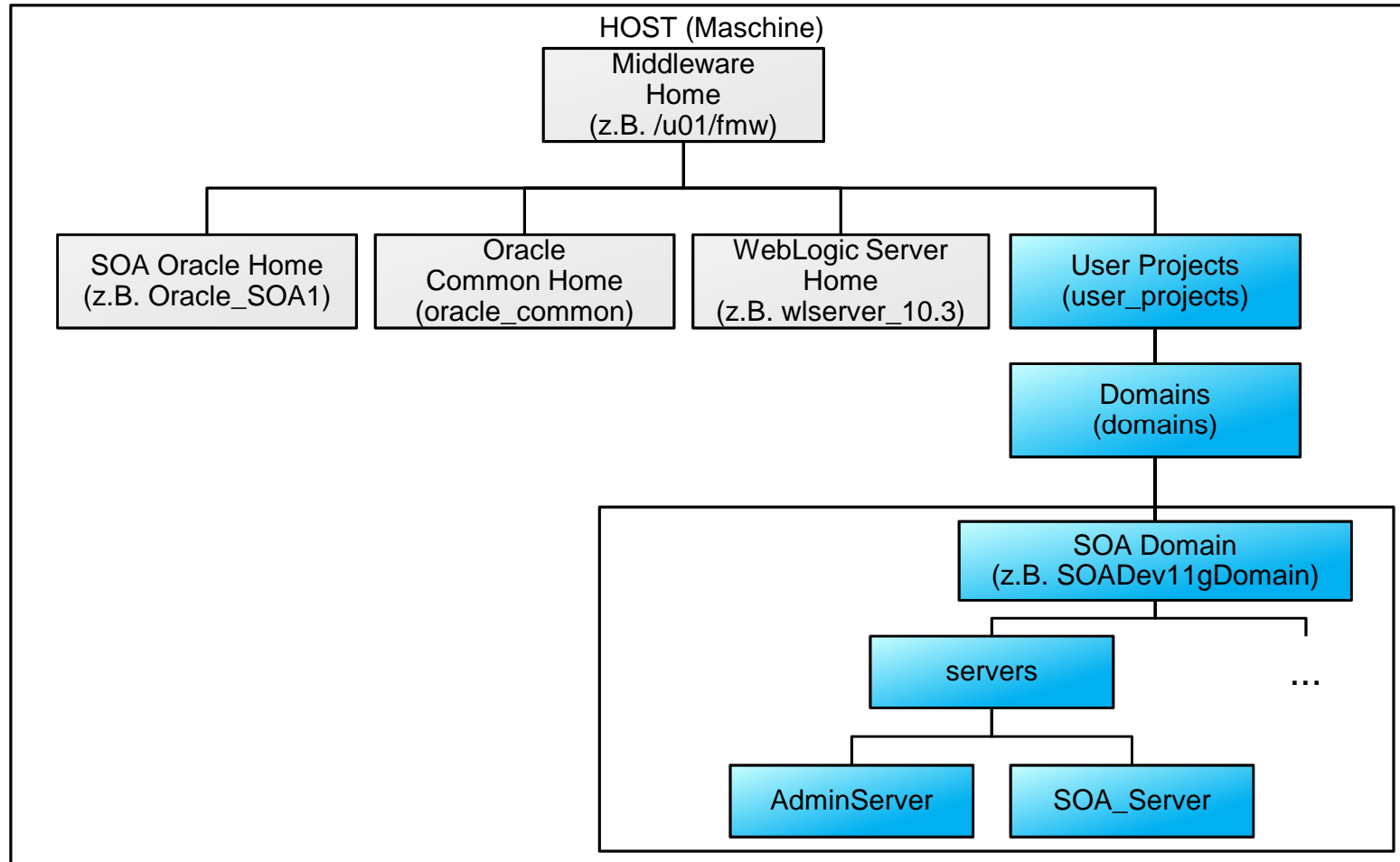

Agenda

- Wichtige Konzepte und Begriffe
- Kopieren von Oracle Fusion Middleware
- Laufzeitüberwachung von Oracle Fusion Middleware



Der Kopierprozess für Middleware Homes

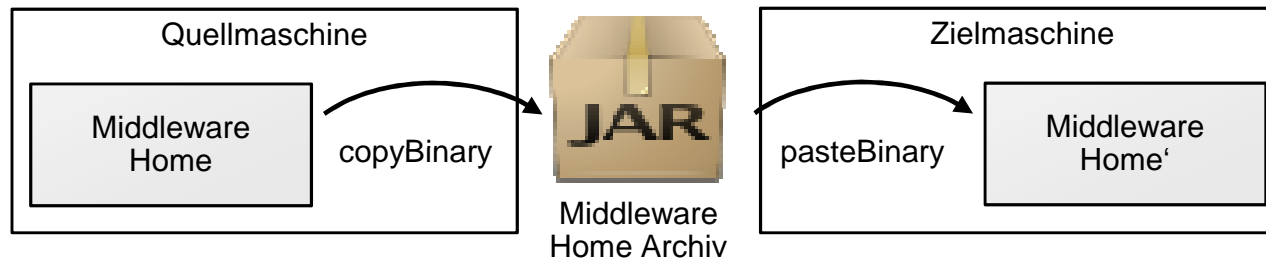

Demo

Kopieren eines FMW Homes

```
oracle@vbox:~/doag2011
File Edit View Terminal Tabs Help
[oracle@vbox doag2011]$ copyBinary.sh -javaHome $JDK_HOME -archiveLoc /home/oracle/doag2011/fmw_clone
.jar -sourceMWHomeLoc /u01/fmw

Log File: "/tmp/CLONE2011-09-13_03-12-18PM-LOG/CLONE2011-09-13_03-12-18PM.log".
Error File: "/tmp/CLONE2011-09-13_03-12-18PM-LOG/CLONE2011-09-13_03-12-18PM.error".

INFO : Sep 13, 2011 3:12:18 PM - CLONE-21009 The Middleware home that will be included in the archive is /u01/fmw.
INFO : Sep 13, 2011 3:12:18 PM - CLONE-21013 Trying to find Oracle home(s) present under Middleware home /u01/fmw...
INFO : Sep 13, 2011 3:12:35 PM - CLONE-21038 The archive will contain both Middleware home /u01/fmw and Oracle home(s) /u01/fmw/oracle_common,/u01/fmw/Oracle_SOA1.
INFO : Sep 13, 2011 3:12:35 PM - CLONE-21154 Checking free space availability for copyBinary operation.
INFO : Sep 13, 2011 3:12:35 PM - CLONE-21155 Required free space is available for copyBinary operation.
To proceed enter "yes", or any other text to abort:
```

```
oracle@vbox:~/doag2011
File Edit View Terminal Tabs Help
[oracle@vbox doag2011]$ pasteBinary.sh -javaHome $JDK_HOME -archiveLoc /home/oracle/doag2011/fmw_clone
.jar -targetMWHomeLoc /home/oracle/doag2011/fmw_clone

Log File: "/tmp/CLONE2011-09-13_04-07-35PM-LOG/CLONE2011-09-13_04-07-35PM.log".
Error File: "/tmp/CLONE2011-09-13_04-07-35PM-LOG/CLONE2011-09-13_04-07-35PM.error".

INFO : Sep 13, 2011 4:07:35 PM - CLONE-21012 The archive will be restored fully at /home/oracle/doag2011/fmw_clone.
INFO : Sep 13, 2011 4:07:35 PM - CLONE-21104 The number of Oracle home(s) and Middleware home present in the archive is 2 and 1 respectively.
█
```

Der Kopierprozess für Java Komponenten

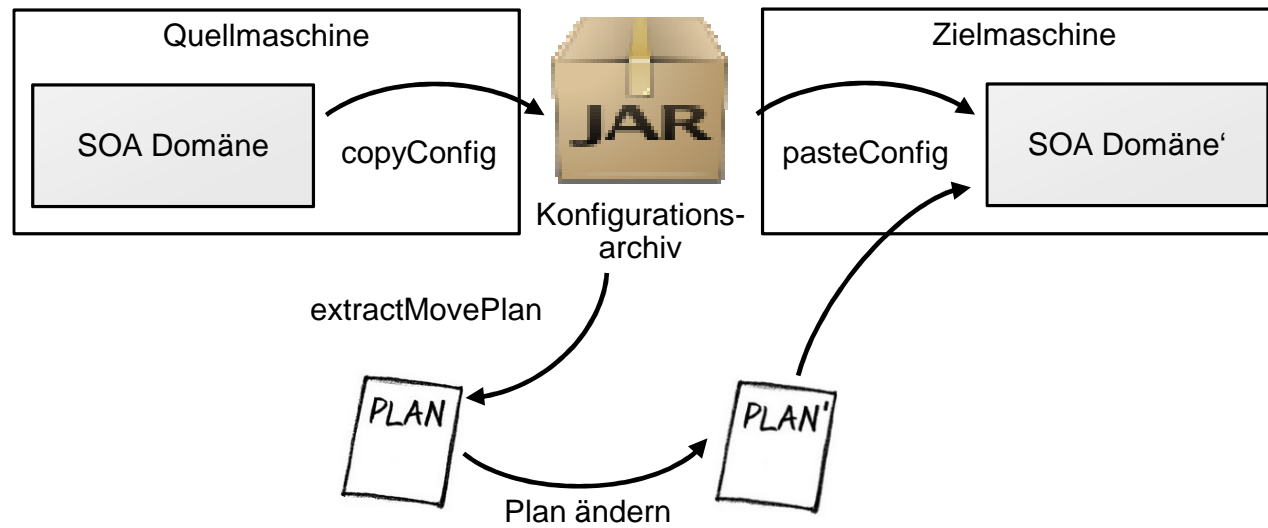

Demo

Kopieren von Java Komponenten

```
oracle@vbox:~/doag2011
File Edit View Terminal Tabs Help
[oracle@vbox doag2011]$ copyConfig.sh -javaHome $JDK_HOME -archiveLoc /home/oracle/doag2011/bpm1lgdomain.jar -sourceDomainLoc /u01/fmw/user_projects/domains/BPM1lgDomain -sourceMWHomeLoc /u01/fmw/ -domainHostName vbox -domainPortNum 7001 -domainAdminUserName weblogic -domainAdminPassword /home/oracle/doag2011/pwd.txt

Log File: "/tmp/CLONE2011-09-13_05-09-40PM-LOG/CLONE2011-09-13_05-09-40PM.log".
Error File: "/tmp/CLONE2011-09-13_05-09-40PM-LOG/CLONE2011-09-13_05-09-40PM.error".

To proceed enter "yes", or any other text to abort:yes
INFO : Sep 13, 2011 5:09:45 PM - CLONE-21095 Create archive for J2EECOMPONENT@BPM1lgDomain started
...
INFO : Sep 13, 2011 5:09:45 PM - CLONE-23270 Connecting to domain runtime...
INFO : Sep 13, 2011 5:09:45 PM - CLONE-23271 Trying to connect to vbox:7001...
█
```

```
oracle@vbox:~/doag2011
File Edit View Terminal Tabs Help
[oracle@vbox doag2011]$ extractMovePlan.sh -javaHome $JDK_HOME -archiveLoc /home/oracle/doag2011/bpm1lgdomain.jar -planDirLoc /home/oracle/doag2011/plans

Log File: "/tmp/CLONE2011-09-13_06-16-59PM-LOG/CLONE2011-09-13_06-16-59PM.log".
Error File: "/tmp/CLONE2011-09-13_06-16-59PM-LOG/CLONE2011-09-13_06-16-59PM.error".

INFO : Sep 13, 2011 6:16:59 PM - CLONE-23300 Configplans have been extracted at "/home/oracle/doag2011/plans".
INFO : Sep 13, 2011 6:16:59 PM - CLONE-23301 ExtractMovePlan operation completed successfully.
[oracle@vbox doag2011]$ █
```

Agenda

- Wichtige Konzepte und Begriffe
- Kopieren von Oracle Fusion Middleware
- Laufzeitüberwachung von Oracle Fusion Middleware



Node Manager startet Admin Server

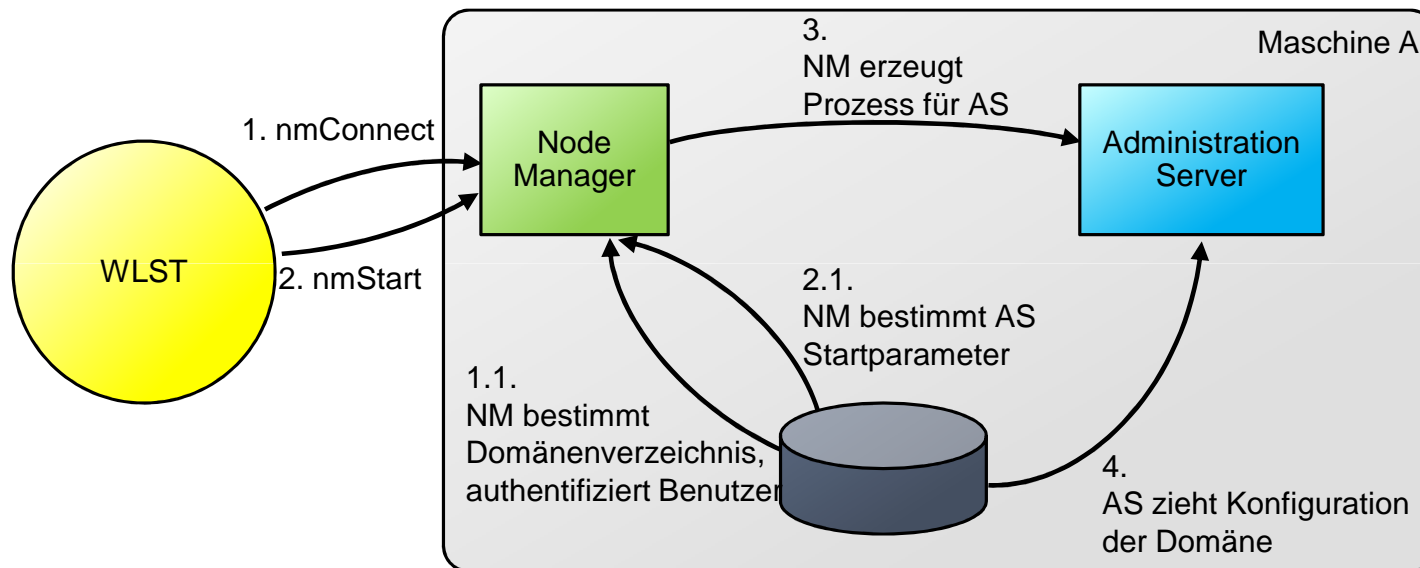

Node Manager in der WebLogic Server Umgebung

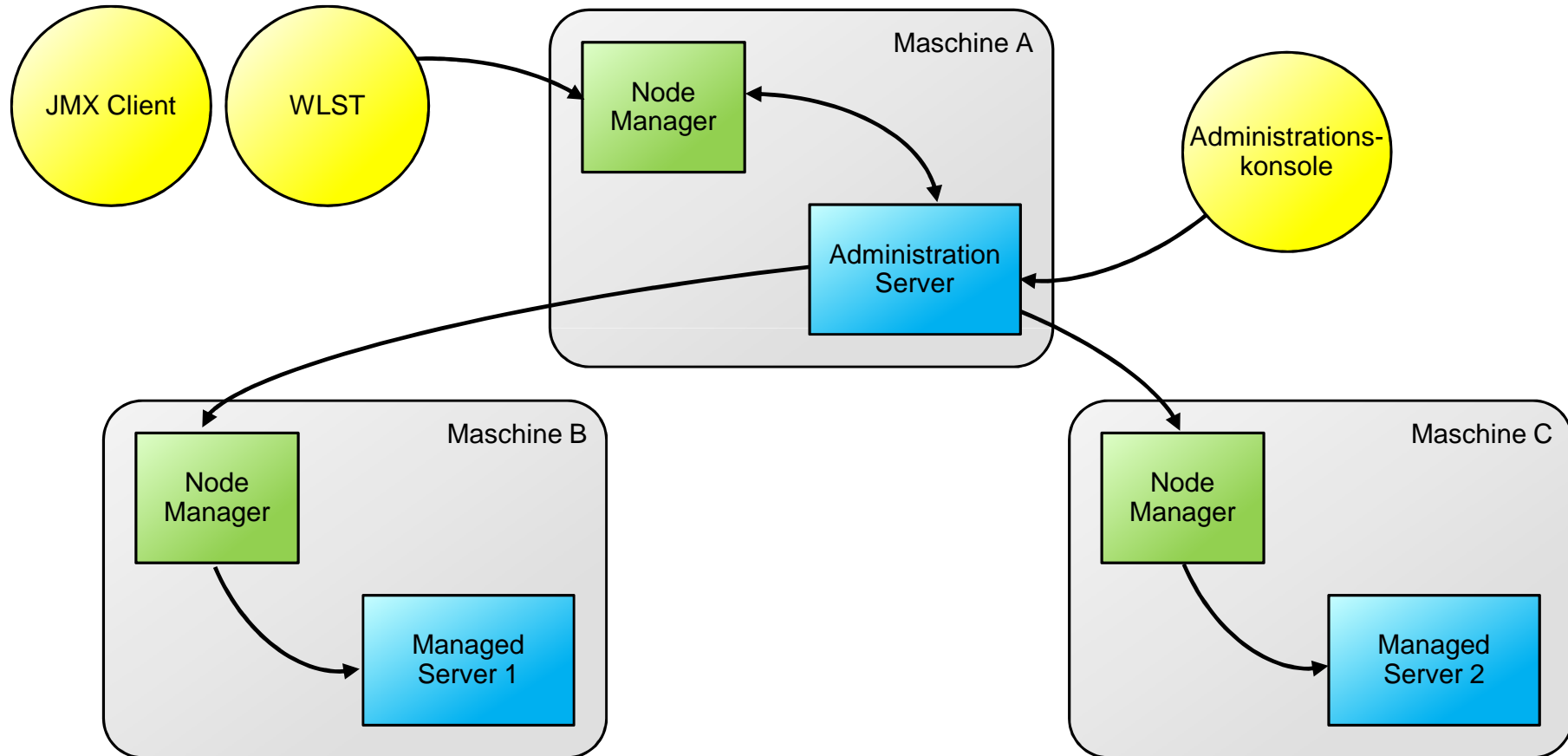

Demo

Start und Restart eines Managed Servers

The image shows a screenshot of the Oracle WebLogic Server Administration Console in a Firefox browser window. The console displays the 'Summary of Servers' page for the 'BPM11gDomain'. The 'Control' tab is active, showing a table of servers. The table has columns for 'Server', 'Machine', 'State', and 'Status of Last Action'. Three servers are listed: 'AdminServer(admin)' (RUNNING), 'managed_01' (SHUTDOWN), 'managed_02' (SHUTDOWN), and 'managed_03' (SHUTDOWN). The 'Start' button is highlighted with a mouse cursor. To the right, a terminal window shows the execution of 'ps aux | grep weblogic' and 'kill -9 31040' commands.

Summary of Servers

Server	Machine	State	Status of Last Action
<input type="checkbox"/> AdminServer(admin)		RUNNING	None
<input checked="" type="checkbox"/> managed_01		SHUTDOWN	None
<input checked="" type="checkbox"/> managed_02		SHUTDOWN	None
<input checked="" type="checkbox"/> managed_03		SHUTDOWN	None

Questions



Hardware and Software

ORACLE®

Engineered to Work Together

ORACLE®

ORACLE®